

Rubber Fab Technologies Group's

SMART CLAMP™



THE "HALF-TURN"
SANITARY SMART CLAMP

- *Faster Change Outs*
- *Half-Turn Installation*
- *Increased Uptime*
- *Ergonomic Benefits*
- *Compression Control*
- *Supports ASME-BPE Seal Performance Requirements*
- *Vibration Resistant*

Smart Clamp™ patent #8,220,113

RUBBER FAB
technologies group

Smart Clamp™

The “Half-Turn” Sanitary Clamp

Rubber Fab is proud to introduce the next generation of sanitary hinge clamps — **the one-piece, completely unitized, Smart Clamp™**. With features that include half-turn installation and faster uptime, the benefits of Rubber Fab’s Smart Clamp™ far exceed any other sanitary clamp.

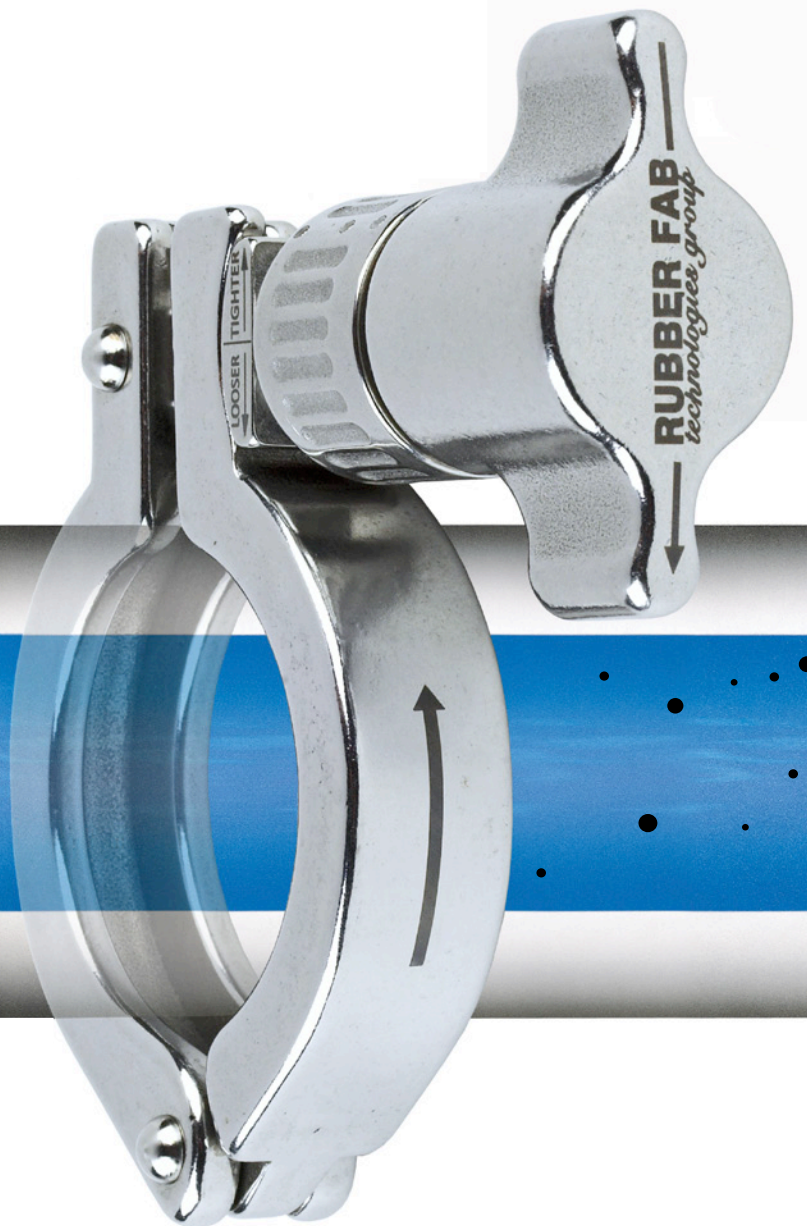

From “Up-Time” to Ergonomics

- Dramatically increased uptime
- Supports ASME-BPE seal performance
- Half-turn installation
- Repetitive stress and ergonomic benefits
- Constant and even compression across gasket face
- Multiple compression settings for sanitary gaskets – no over or under tightening of gasket
- Extends gasket’s service life
- Deeper clamp channel nests ferrules and evenly distributes force over the gasket’s face
- Single unitized unit - no additional parts
- Threadless system minimizes soil and bacterial entrapment
- Clamp hinge and locking arm will not collapse
- User-friendly
- No tools required

Maintaining a Sanitary System

One of the greatest production challenges is **maintaining a sanitary system**. Gaskets form an integral part of every sanitary system— for an effective seal, **appropriate gasket choice, correct installation and proper compression are necessary**.

Application requirements will dictate gasket choice and all tri-clamp® gaskets must be seated properly within the pipe ferrules if they are to seal effectively. The **application of proper torque** will then provide for a substantially flush, or perfect surface, seal.

An over-tightened gasket will intrude into the pipe I.D. and lead to erosion of the gasket and contamination of the process stream. The gasket intrusion will also cause a damming effect inside the pipeline allowing soil and bacteria to collect. If additional torque is applied, the stress upon the gasket can cause tearing and additional process contamination (see A in illustration).

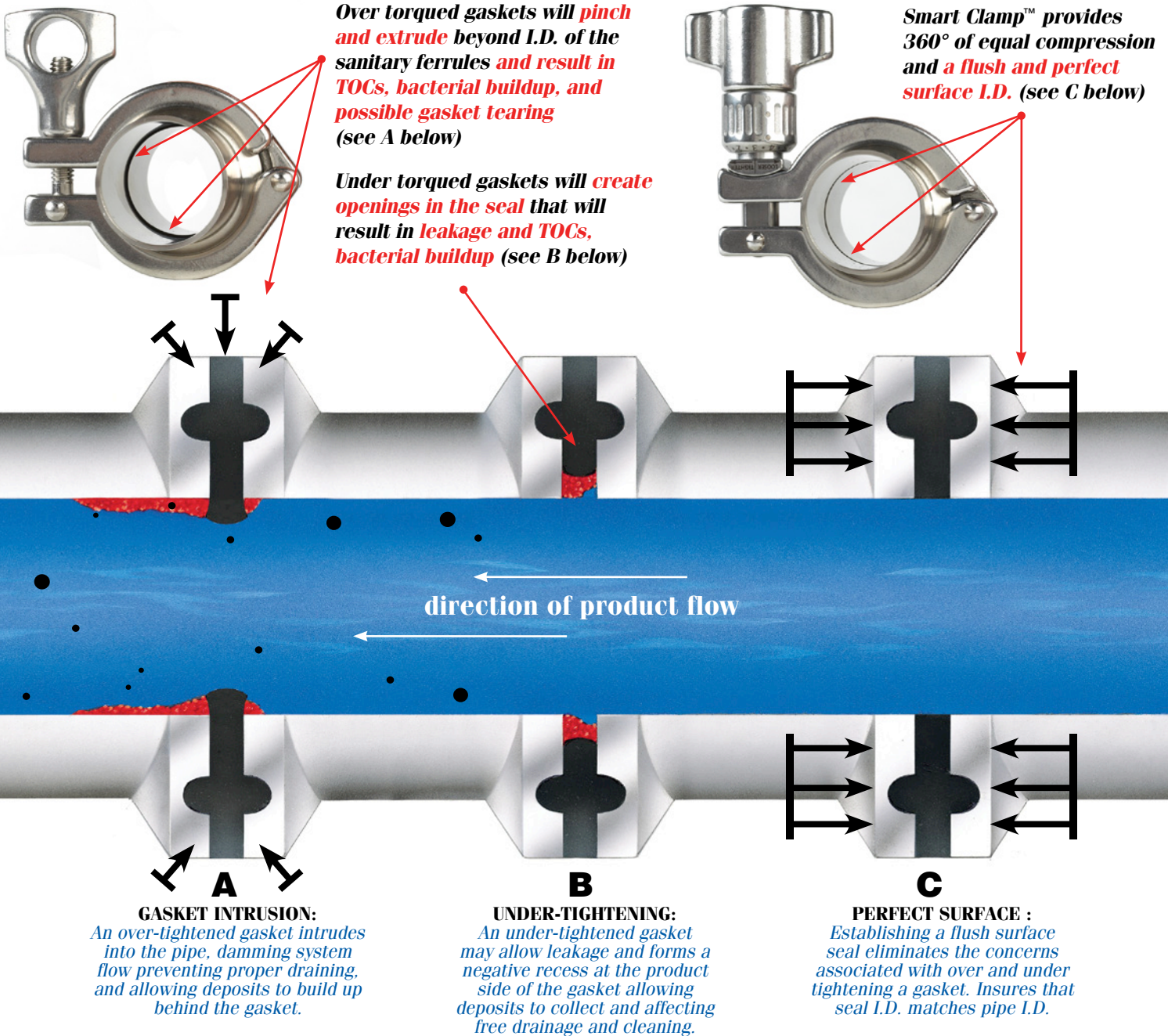

When a gasket is under-tightened, the result is a negative recess between the ferrules allowing soil and bacteria to accumulate and become entrapped (see B in illustration).

Rubber Fab's Smart Clamp™ fully supports ASME-BPE Seal Performance Standards. Smart Clamp provides accurate gasket alignment, multiple settings for proper torque, and 360° equal compression to support perfect surface results.

360° of Equal Compression

When tightened, the deep channel design of the Smart Clamp™ provides an equal amount of force onto the pipe ferrules and across the face of the gasket (see C in illustration). Unlike the top-down pinching effect associated with traditional wing-nut clamps (see A),

the Smart Clamp's™ balanced compression prevents gasket I.D. intrusion and helps eliminate the stretching and tearing associated with over torqued gaskets and extending the service life of the gasket.

Multiple Settings for Multiple Gaskets

Rubber Fab understands that one gasket does not meet every system's needs. This is why the Smart Clamp™ is **pre-set with multiple torque settings** that have been tested and designed to work with all Rubber Fab Type I and Type II (Flanged) tri-clamp elastomeric gaskets – Tuf-Flex®, Eco-Flex, Silicone, FKM, EPDM, and Buna. Please call Rubber Fab Technical Sales with your system requirements, gasket selection and for a list of gasket user settings.

Don't Re-Torque...Replace

A common sign that a system is beginning to fail is when a gasket connection begins to weap. The traditional answer is to simply re-torque the clamp to try and eliminate the weepage. You "believe" you are fixing the problem, but in reality, you are creating a far worse situation by pushing the gasket beyond its limits. **Smart Clamp™ provides proper torque** from the moment of install.

Another common reason for re-torquing is when a connection becomes loose. In systems with harmonic vibrations there is a concern that traditional wing-nut clamps will become loose. **Smart Clamp™ has successfully been tested to withstand mechanical vibrations** inherent in systems with pumps and other repetitive vibration prone equipment.

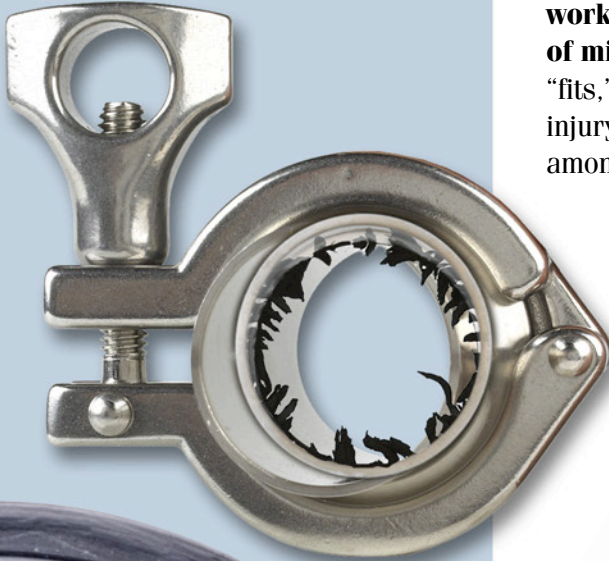

Sealing surface, because of over compression, intrudes into sanitary tube I.D. obstructing flow, knocking off particles and contaminating product

Tears and rips from over compression

SAFETY SMART: Smart Clamp™ is Designed to Help Prevent and Decrease Repetitive Strain Injury Conditions

Repetitive Strain Injury (RSI) (also known as repetitive stress injury, repetitive motion injury, repetitive motion disorder (RMD), occupational overuse syndrome, and regional musculoskeletal disorder) is an injury of the musculoskeletal and nervous systems that can be caused by repetitive tasks, forceful exertions, vibrations, mechanical compression (pressing against hard surfaces), or sustained or awkward positions.

Repeating such motions, multiple times, during the course of normal work or other daily activities can result in repetitive motion disorders.

Smart Clamp™ is designed to address these RSI workplace conditions and job demands to the capabilities of the working population as outlined in the thumb-finger grip of military spec MIL-STD-1472E. Effective and successful "fits," or fixes, assure high productivity, avoidance of illness and injury risks, workman's comp claims, and increased protection among the workforce.

Common examples of RSI are:

- Carpal Tunnel Syndrome
- Tendonitis
- Bursitis
- Tennis Elbow
- Trigger Finger

The Smart Clamp™ ergonomic design and "half-turn" installation decreases working conditions that are known to result in Repetitive Stress Injury



Smart Clamp's™ “Half-Turn” Installation

It doesn't get any easier or faster than the half-turn installation of the Rubber Fab Smart Clamp™. In highly repetitive use industries such as pharmaceutical and bio-pharmaceutical manufacturing plants, pilot plant facilities, SKIDs or where the use of transfer panels, hose to tank, and SOPs are common place, time is money — faster is better! **Using a filtration system of orifice plates and screens?** Get faster up-time! Clean out backed up screens and have your system up and running faster.

Making Tough Spots Easy

Having trouble with installations in tough or awkward conditions and positions? Under tanks? Over head? In a corner? Rupture discs? Smart Clamp™ can help. With a hinge that doesn't collapse, Smart Clamp™ can easily be positioned and controlled around tough installation locations. The **deeper clamp channel allows the ferrules and gasket to properly nest together ensuring proper alignment.** And because the Smart Clamp™ will not close unless the gasket is properly aligned, you can have confidence that installation is correct in all spots.

Smart Clamp™ Installation



Standard Clamp Installation

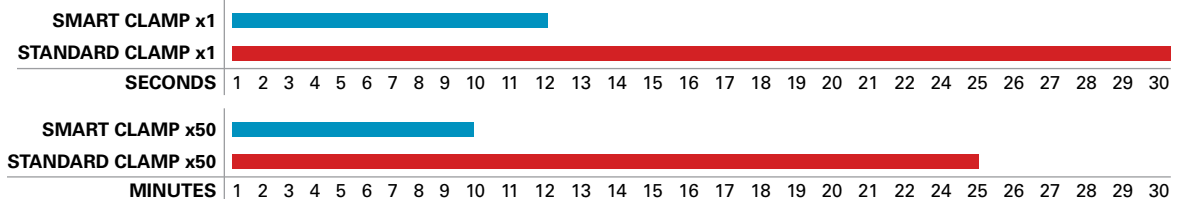
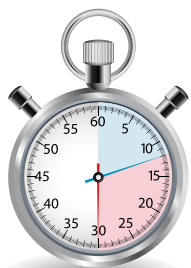
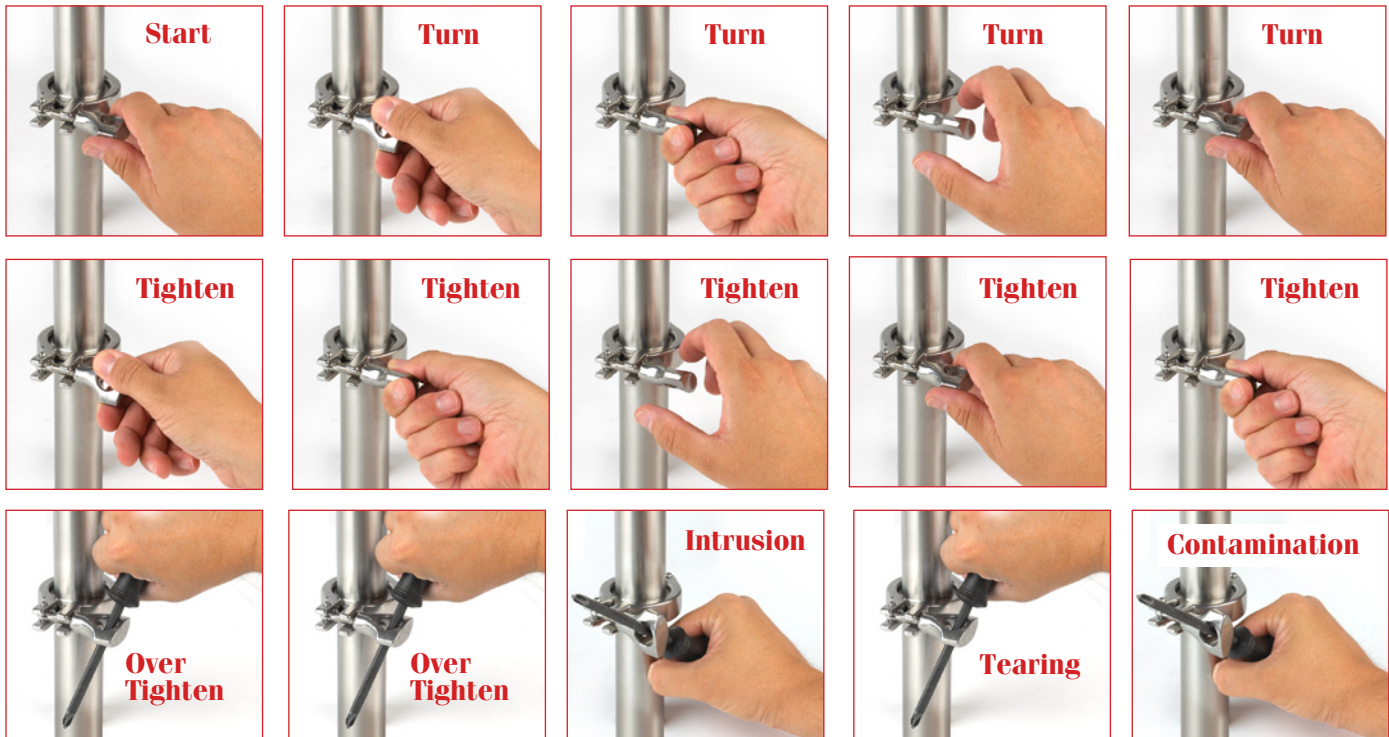

UPTIME Time is based on typical gasket change out. Time is to open clamp, change out gasket, and close clamp. For this demonstration, ten seconds are included to each gasket change out.

Smart Clamp™

Features Summary:

Nesting Clamp Channel

Deeper clamp channel eliminates play between the ferrules and gasket locking them together for perfect surface alignment. In fact, the Smart Clamp™ WILL NOT lock if the gasket is not properly aligned.

Unitized Clamp System

Unlike traditional clamps with a clamp and a wing nut, Smart Clamp™ is one piece for ease of use.

Easy Adjust Dial - Multiple Settings

The Smart Clamp™ quick turn dial allows for quick and accurate torque for multiple Rubber Fab gaskets.

Beveled Lip-Lock

When engaged, the Smart Clamp™ compression base seats perfectly into the beveled lip-lock securing installation and prevents disengagement if accidentally knocked or hit.

Non-Collapse Clamp

Because the Smart Clamp™ clamp will not collapse, installation is quicker and easier, especially in difficult to reach and awkward installation locations.

Ergonomic Benefits

The Smart Clamp™ “half-turn” installation not only increases uptime but decreases conditions related to repetitive stress injuries.

UP TIME!! UP TIME!! UP TIME!!

There is no faster or easier way to install a gasket then with Rubber Fab's Smart Clamp™ “half-turn” installation.

Smart Clamp is a one-piece unitized sanitary hinge clamp system - no parts to assemble

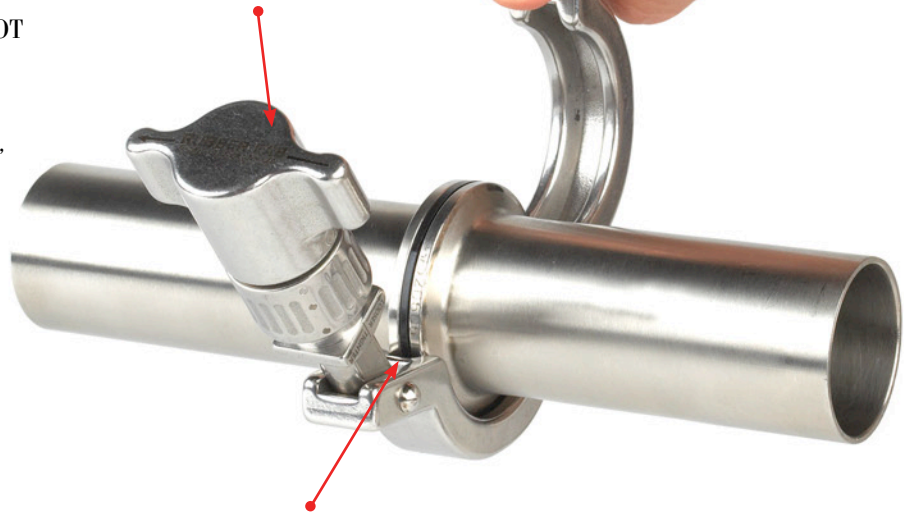

Nested ferrules and gasket are locked in place ensuring gasket alignment

Easy adjust dial with multiple torque settings makes adjusting the Smart Clamp™ quick and simple

Deeper clamp channel nests ferrules and gasket in place ensuring gasket alignment



Each clamp is lot and batch traceable.

Visual indicator lets you know Smart Clamp™ is fully engaged and installed when the arrow on the clamp and the arrow on the handle are pointing to each other!

The Smart Clamp™ beveled lip-lock holds clamp in place if setting needs to be adjusted and in case of accidental hit

User-friendly handle and half-turn installation helps prevent repetitive strain injury conditions.

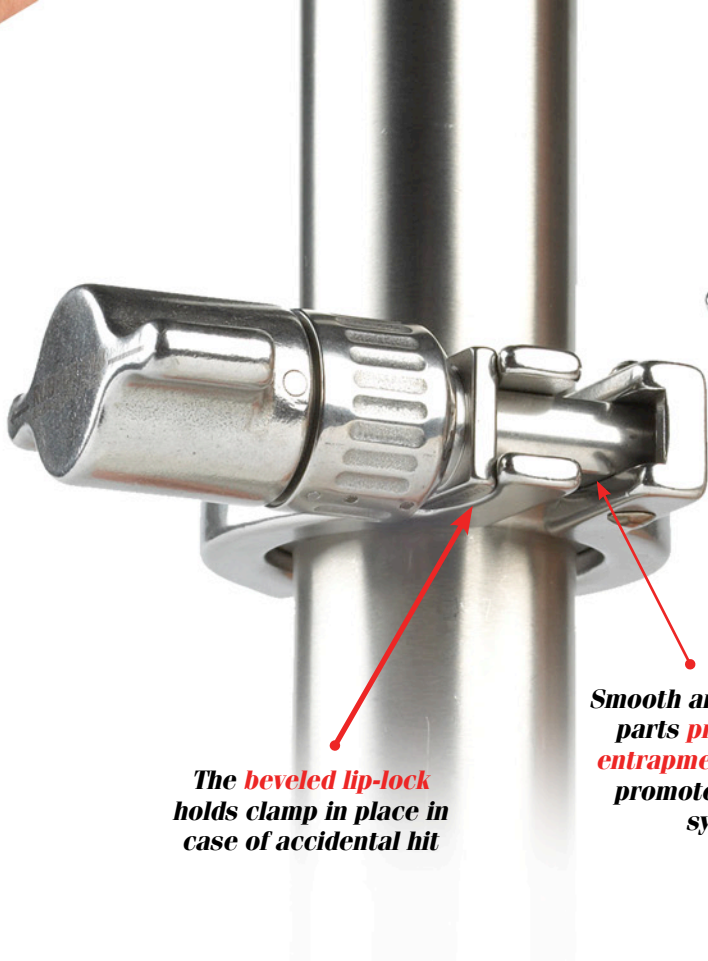

The beveled lip-lock holds clamp in place in case of accidental hit

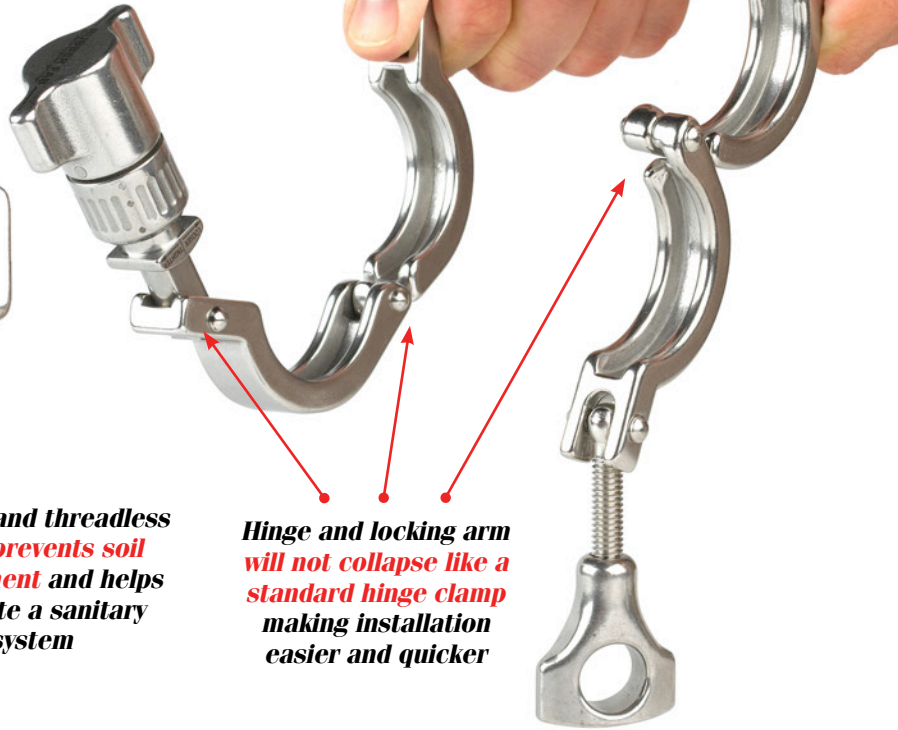

Smooth and threadless parts prevents soil entrapment and helps promote a sanitary system

Hinge and locking arm will not collapse like a standard hinge clamp making installation easier and quicker



Engaged Visual Indicator You know Smart Clamp™ is installed when the arrows are pointing to each other!

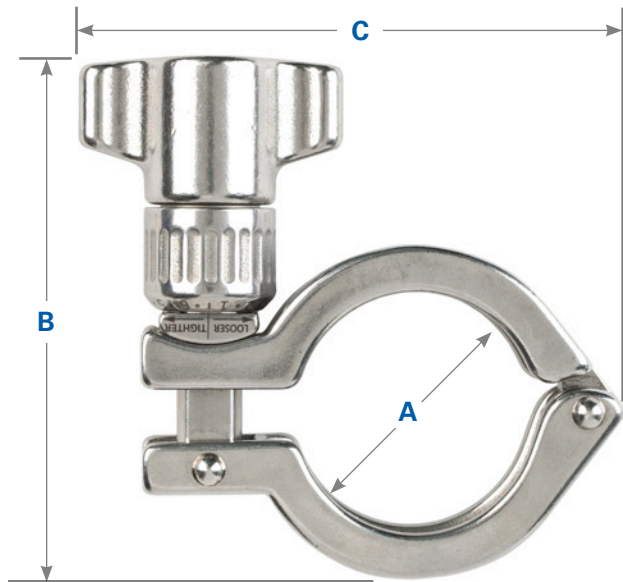

SIZE	Part Number	Dimension in Inches			Service Pressure Rating	
		"A"	"B"	"C"	@ 70°F psi	@ 250°F psi
1/2" & 3/4"	SMARTCLAMP-050/075	CF	CF	CF	1500	1200
34 mm	SMARTCLAMP-34MM	1.50	3.88	3.50	500	250
1" & 1-1/2"	SMARTCLAMP-100/150	2.90	4.00	4.25	500	250
2"	SMARTCLAMP-200	2.72	4.50	4.75	450	250
2.5"	SMARTCLAMP-250	3.25	4.75	5.50	500	200
3"	SMARTCLAMP-300	3.76	5.00	5.75	350	150
3" Sch 5	SMARTCLAMP-300-V	4.32	5.38	6.25	350	150
4"	SMARTCLAMP-400	4.89	5.50	6.87	200	125
6"	SMARTCLAMP-600	6.77	6.50	9.00	100	50



Smart Clamp™

Works with all Rubber Fab Hose and Hose Assemblies

Rubber Fab's Hose, Hose Assemblies, Tubing, Fittings and Adapters

High Purity Platinum Silicone Hose, Tubing, Sanitary Molded Ends

PTFE & FEP Lined Smooth Bore & Convolute Hose

Metal Hose

FDA Rubber Hose

FDA PVC Hose, Tubing, Sanitary Molded Ends

Sight Gauges: PTFE & Polysulfone

Fittings & Adapters: 316L, Special Alloys & Non Metallic

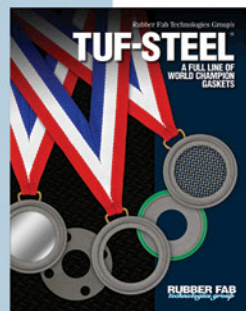
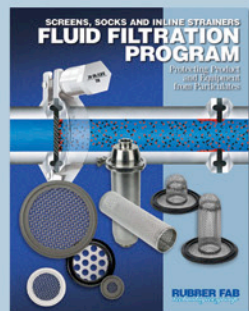
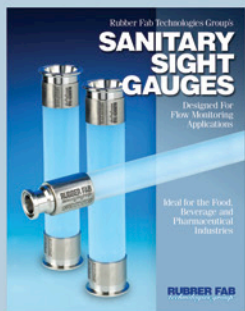

™ Smart Clamp is a trademark

© Tuf-Flex is a registered trademark of Rubber Fab Technologies Group

© Tri-Clamp is a registered trademark of The Ladish Co.

Smart Clamp™ patent #8,220,113

RUBBER FAB

technologies group

Rubber Fab Technologies Group

26 Brookfield Drive • Sparta, NJ 07871

phone: 973-579-2959 • fax: 973-579-7275

www.rubberfab.com

Rubber Fab Technologies Group is a member of:

Distributed by:

ISPE



International Association of Food Industry Suppliers

fisa

Distributors Serving Sanitary Processing



THE ASSOCIATION FOR HOSE AND ACCESSORIES DISTRIBUTION